

Placement of lampshades

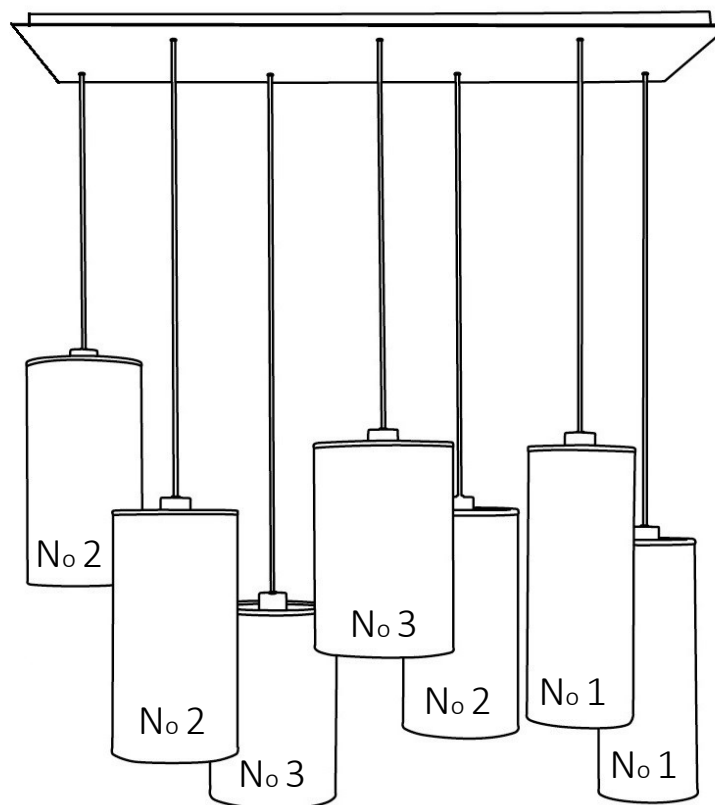

No 1 : Ø15 - 15 - 40cm
No 2 : Ø18 - 18 - 35cm
No 3 : Ø20 - 20 - 30cm



ZIBAL 7

FR MONTAGE *de la base plafond avec cadre*

1. Cette notice est valable pour les bases-plafond des suspensions carrées ou rondes de grand format.
2. Après déballage, dévissez la plaque (2) avec câbles et douilles pour la séparer de son cadre (1).
3. Fixez ce cadre (1) au plafond. Utilisez des vis et des chevilles adaptées au type de plafond et au poids de votre suspension (*voir fiches produit sur notre site web*). Raccordez le fil de terre à la connexion prévue sur le cadre.
4. Raccordez votre arrivée de courant aux connexions électriques au dos de la plaque (2) et revissez cette plaque avec câbles et douilles au cadre (1).
5. Placez vos structures, ampoules ou verres aux différentes douilles.

NL MONTAGE *van de plafondbasis met kader*

1. Deze instructie is geldig voor plafondbasisen van vierkante of ronde grote hanglampen.
2. Na het uitpakken, schroef de plaat (2) met kabels en fittingen los om deze van de kader (1) te scheiden.
3. Bevestig dit kader (1) aan het plafond. Gebruik schroeven en pluggen die zijn aangepast aan het type plafond en het gewicht van uw hanglamp (*zie product fiche op onze website*). Verbind de aardingsdraad aan de voorziene bevestiging op de kader.
4. Verbind de stroomtoegang aan de elektrische aansluitingen aan de achterkant van de plaat (2) en schroef deze plaat met kabels en fittingen op de kader (1).
5. Plaats uw structuren, gloeilampen of glazen aan de verschillende fittingen.

EN MOUNTING *of the ceiling base with frame*

1. This notice is valid for ceiling bases of square or round large suspensions.
2. After unpacking, unscrew the plate (2) with cables and fittings to separate it from its frame (1).
3. Attach this frame (1) to the ceiling. Use screws and plugs adapted to the type of ceiling and the weight of your suspension (*see product card on the website*). Connect the ground wire to the provided connection on the frame.
4. Connect the power supply to the electrical connections on the back of the plate (2) and screw this plate with cables and fittings to the frame (1).
5. Place your structures, bulbs or glasses to the different fittings.

DE MONTAGE *von die Deckenbasis mit Rahmen*

1. Diese Anleitung gilt für Deckenbasissen für quadratische oder runde grossmatige Pendelleuchte
2. Nach dem Auspacken, schrauben Sie die Platte (2) mit Kabeln und Fassungen ab, um sie von ihrem Rahmen (1) zu trennen.
3. Befestigen Sie diesen Rahmen (1) an der Decke. Verwenden Sie Schrauben und Dübel, die an die Art der Decke und das Gewicht Ihrer Pendelleuchte angepasst sind (*siehe Produktblatt auf der Webseite*). Verbinden Sie das Erdungskabel mit dem Anschluss am Rahmen.
4. Schließen Sie die elektrische Zuleitung an die elektrischen Anschlüsse auf der Rückseite der Platte (2) und schrauben Sie diese Platte mit Kabeln und Fassungen am Rahmen (1) fest.
5. Platzieren Sie Ihre Strukturen, Leuchtmittel oder Gläser zu den verschiedenen Fassungen.

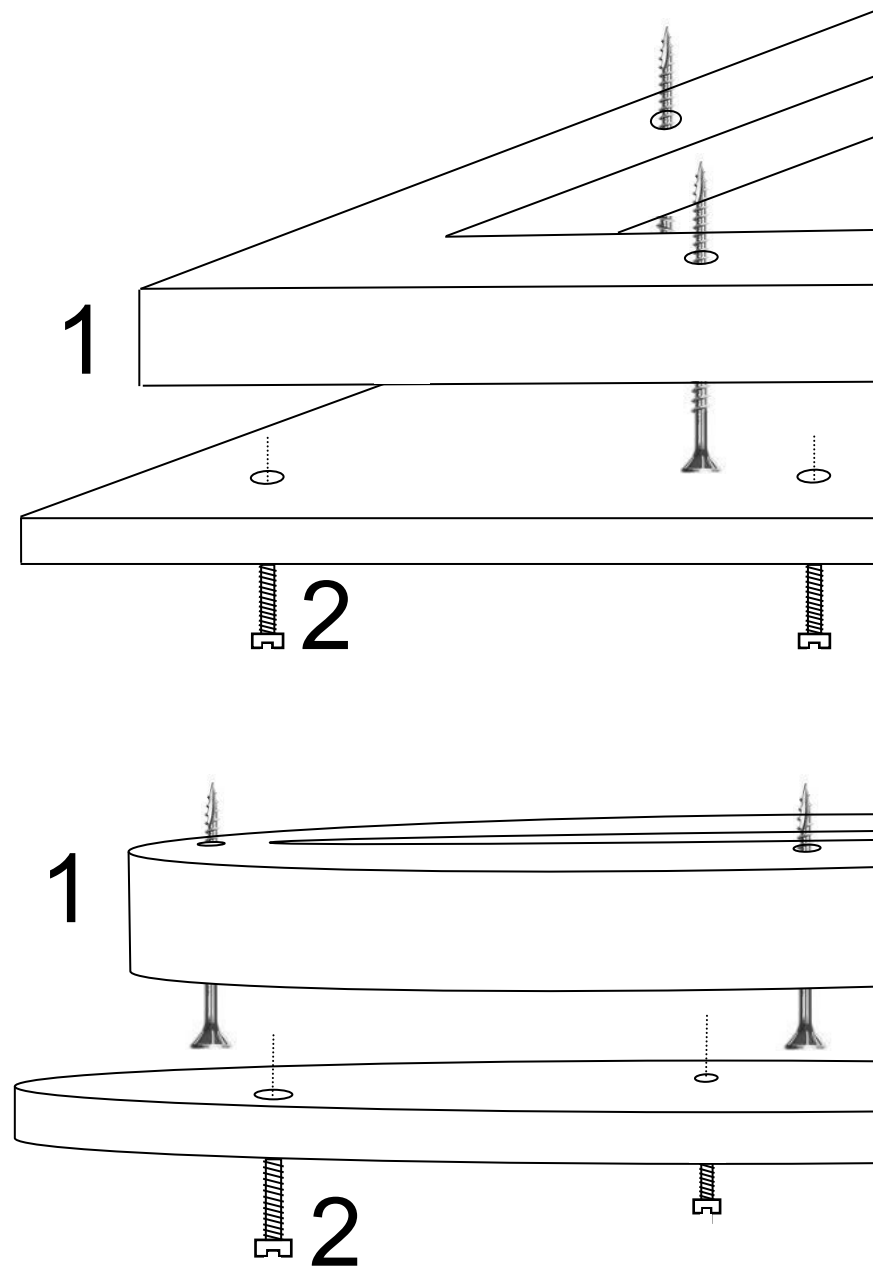

CEILING BASE with frame





Manufacturer : DAVIDTS LIGHTING – Brussels – Belgium – www.davidts.com

Installation and security instructions (please read and save)

This luminaire is manufactured according to European directives and standards relating to quality and safety of lighting fixtures. A declaration of conformity is available by downloading on our site.

Description of the lighting

Lighting for fixing to the wall or ceiling with handmade lampshade(s) with a soft and pleasant light distribution. More pictures, drawings and complete descriptions are available on our website.

Environmental protection

Our packaging is made from 100% recyclable or re-usable material. For care of the environment please sort or recycle. Fluorescent bulbs and waste electrical equipment should not be disposed of with household waste please take to a recycling facility. This fixture is essentially composed of solid brass. This metal and other elements are fully recyclable. At end of life, if you take the fixture to a recycling facility, each metal will be recovered for new metal production.

Installation of the lighting

This lighting is only intended for indoor use, it must be installed away from moisture, splashing and sources of heat. Suitable for direct mounting on normally flammable surfaces. Before starting the installation, ensure the electrical supply is OFF at the circuit breaker in the consumer unit. Only switching OFF at the wall switch is not adequate.

Carefully remove all packaging. All of our fixtures are fixed to the wall or to the ceiling by means of a mounting plate (placement is done by means of screws and dowels, not supplied). Some of our luminaires have more detailed installation instructions (attached to this document). Please read carefully before starting the installation.

If your light lighting has a fitting with lampshade ring, unscrew it in order to secure the lampshade to the fitting. If the lampshade is made with a seam, make sure that it is positioned towards the back of the light. Screw down the ring carefully. Place the bulb (not supplied) without forcing into the fitting. If necessary straighten the lampshade, only by carefully flexing the metal rods of the lampshade.

If you have any doubt about the installation of this lighting, please contact a qualified electrician.

Inserting or replacing a bulb

Always ensure the electrical supply is OFF before this operation. If necessary, let the old bulb to cool for 10 minutes before removing. Place the bulb without forcing into the fitting. Do not directly touch it with the fingers, but with a cloth (fingerprints reduce the lifetime of a bulb). Be always attentive to the choice of a bulb, never exceed the maximum power (W) authorized, indicated on the labels of the light fitting. If an integral LED bulb attached to the fixture is defective, please contact your distributor.

Maintenance of your lampshades

When your lampshade is dusted use only a brush suitable for delicate fabrics. Never rub the lampshade with a damp cloth or with water. Stains or marks on lampshades can't be removed, attempting removal will risk increasing the surface of the stain. In the case of a disaster, only a new lampshade can recover the original beautiful aspect and clarity of your lighting. To do this please contact your distributor.

Maintenance of your lighting

Because smoke and dust particles in the air are attracted by a heat source, a deposit will appear on the fixture in the course of time. For maintenance, allow the bulb to cool for at least 10 minutes. Clean the fixture with a paper towel soaked with glass cleaner. Never use solvents, abrasive or corrosive products. Never immerse the fixture in water. If the wires are damaged, they must be replaced by a qualified electrician. This fixture must never be modified as this can make it dangerous to use.