

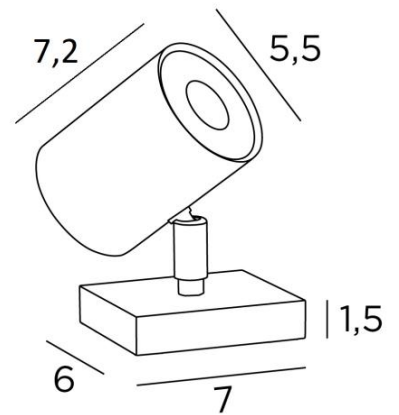

MAGELLAN PL



MAGELLAN PL in light bronze. Metal finish code: 28



Illuminating an object or a picture is very easy with this table spotlight. **MAGELLAN PL** is a luminaire with a fully movable spotlight, which is perfectly suited to this type of lighting

MAGELLAN PL is equipped with a bulb that is completely integrated in the spotlight, which ensures efficiency and discretion

Switch on the cord and without transformer (GU10 fitting - 230V for LED bulb)

OVERALL SIZES

H10,5cm→11,5cm

BASE

Solid brass base : 6 x 7 x 1,5cm

TECHNICAL DATA

One GU10 fitting

Table light mounted on a 360° adjustable joint

Spot dimensions: Ø5,5cm L7,2cm

No converter, this spotlight works directly on 230V

A switch is installed on the electrical cord

Mandatory use of an LED bulb (safety)

AVAILABLE METAL FINISHES AND CODES



01 - Structured white - 6013 001

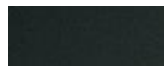

02 - Structured black - 6013 002



25 - Brushed brass - 6013 025



28 - Light bronze - 6013 028



29 - Brushed bronze - 6013 029



32 - Brushed chrome - 6013 032

