

# MERCURE 4

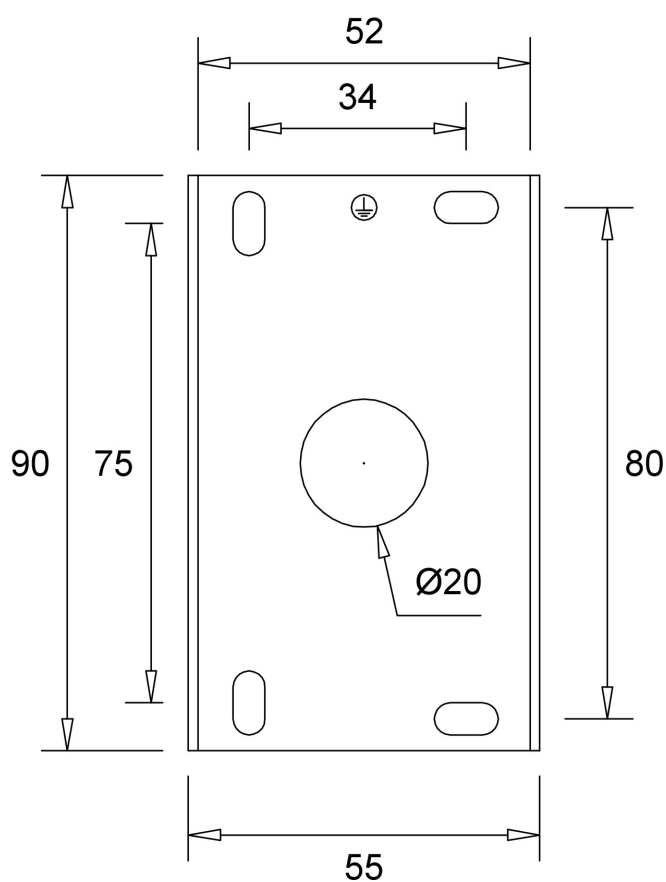

**DAVIDTS LIGHTING sprl**

Chaussée de Waterloo, 848-856 - B-1180 Brussels - Belgium  
T +32.2.375.76.46 - F +32.2.375.82.65  
info@davidts.com - www.davidts.com